

**ECOBLOC MAXX AND AND FLEX ATTENUATION**

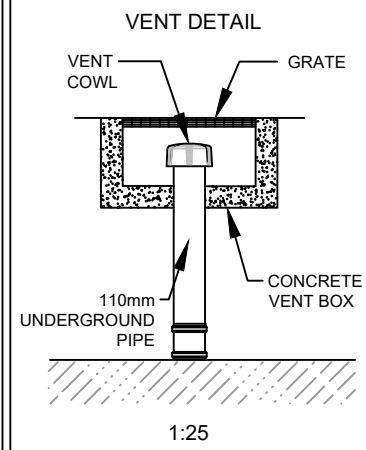
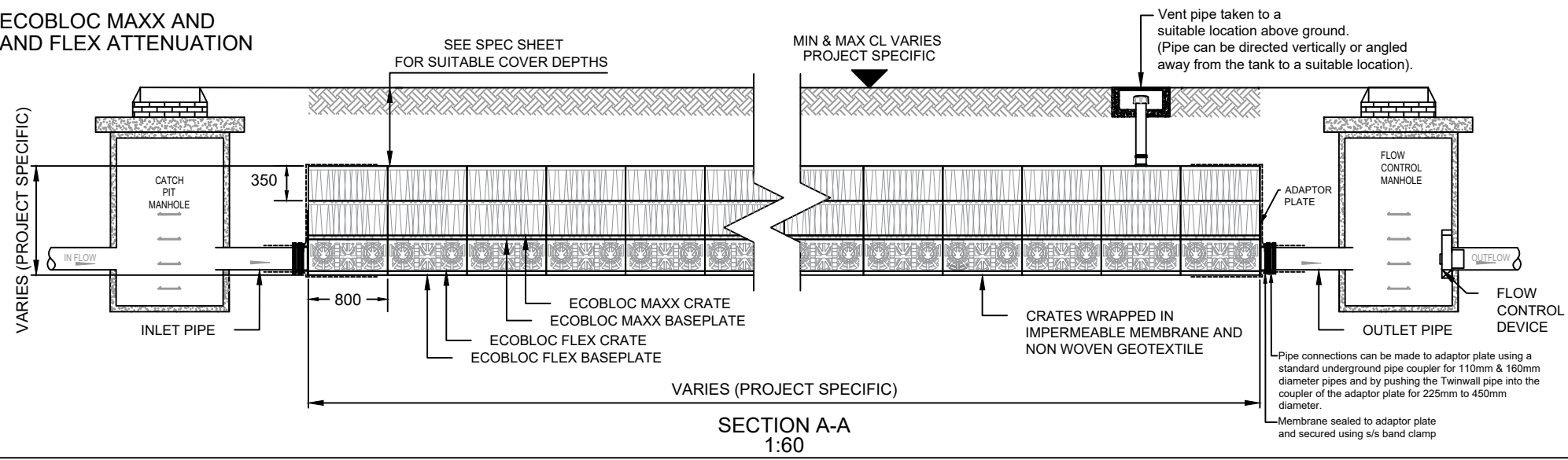

NB. The attenuation tank must be vented to a suitable location above ground and it is recommended to have one Ø110mm vent pipe for every 7,500m<sup>2</sup> of impermeable catchment area.

THIS DOCUMENT IS SUPPLIED IN STRICT CONFIDENCE AND MUST NOT BE LENT, REPRODUCED OR DISCLOSED TO ANY THIRD PARTY WITHOUT THE WRITTEN CONSENT OF GRAF UK LIMITED

**DO NOT SCALE - IF IN DOUBT ASK**

Notice: This drawing is issued only as a guideline and is an estimate of the materials required to construct the drainage system, it should not be used for construction purposes.

Graf UK Ltd makes no warranty or guarantee in relation to the suitability of any of the layout details shown on this drawing in relation to a particular scheme.

- NOTES:-
- All dimensions in mm, unless otherwise stated.
  - All dimensions are nominal and may vary within manufacturing tolerances.
  - All site temporary enabling works by others.
  - Graf products to be installed in strict accordance with Graf recommendations.
  - This drawing is intended for guidance only. Confirmation of the suitability for a particular project should be sought from the consulting engineers prior to final design or commencement of any construction works.

**ECOBLOC MAXX**

	Crate	Baseplate
Dimensions (mm)	800 x 800 x 350	800 x 800 x 40
Gross Volume (m <sup>3</sup> )	0.225m <sup>3</sup>	0.025m <sup>3</sup>
Net Volume (m <sup>3</sup> )	0.217m <sup>3</sup>	0.020m <sup>3</sup>
Material	Polypropylene	Polypropylene
Weight	9kg	4kg
Void Ratio	>96% depending on number of layers	
Inspectable	Yes, when combined with EcoBloc Flex	

**ECOBLOC FLEX**

	Crate	Baseplate
Dimensions (mm)	800 x 800 x 320	800 x 800 x 40
Gross Volume (m <sup>3</sup> )	0.205m <sup>3</sup>	0.025m <sup>3</sup>
Net Volume (m <sup>3</sup> )	0.199m <sup>3</sup>	0.020m <sup>3</sup>
Material	Polypropylene	Polypropylene
Weight	8kg	4kg
Void Ratio	>96% depending on number of layers	
Inspectable	Yes	

**MAXX AND FLEX COMBINATION**

*UCS Vertical	255 kN/m <sup>2</sup>
*UCS Lateral	82 kN/m <sup>2</sup>

\*Ultimate Compression Strength

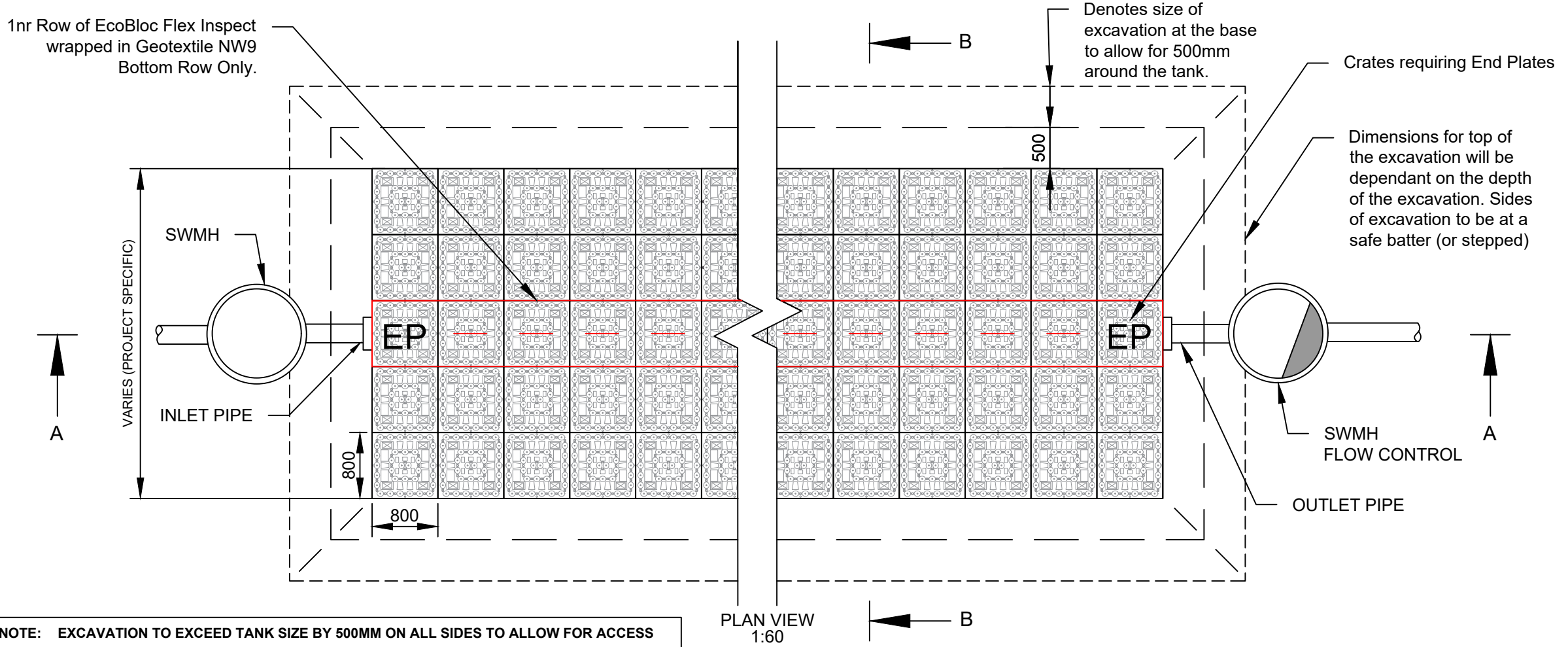

**NOTE: EXCAVATION TO EXCEED TANK SIZE BY 500MM ON ALL SIDES TO ALLOW FOR ACCESS**

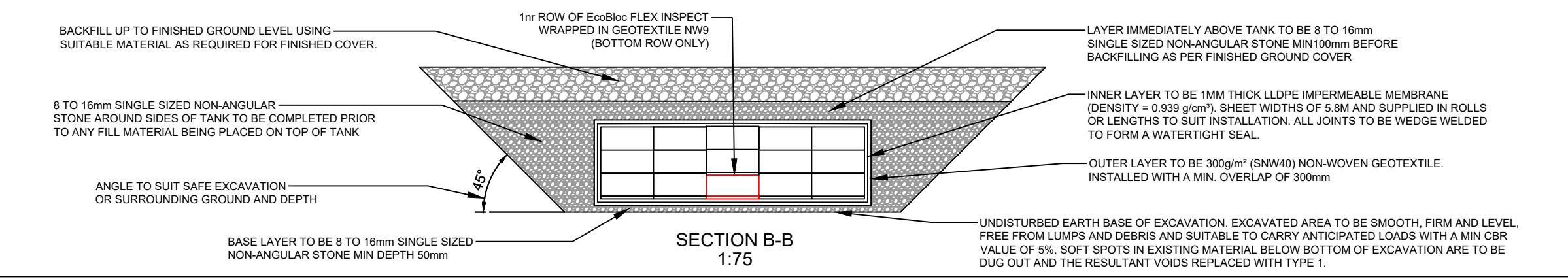

P2	REVISED NOTES	AP	21.09.22
P1	LATEST REVISION	AP	05.03.21
REV.	DESCRIPTION	BY	DATE



GRAF UK Limited, Regen House, Beaumont Road, Banbury, Oxfordshire, OX16 1RH  
 T: 01608 661500 F: 01295 211333  
 E: info@grafuk.co.uk www.grafuk.co.uk

DRAWN : AP DATE : 05.03.2021  
 CHECKED : MC SCALE : VARIOUS@A3

PROJECT  
**GRAF STANDARD DETAILS**

DESCRIPTION  
**ATTENUATION TANK using GRAF ECOBLOC MAXX AND FLEX**

DRAWING No. **STANDARD DETAIL\_MAXX AND FLEX** REV. **P2 (Pg.1)**



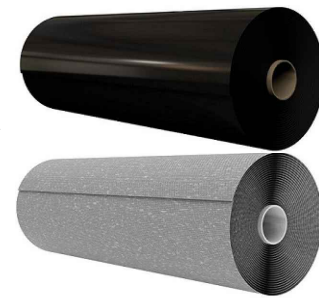
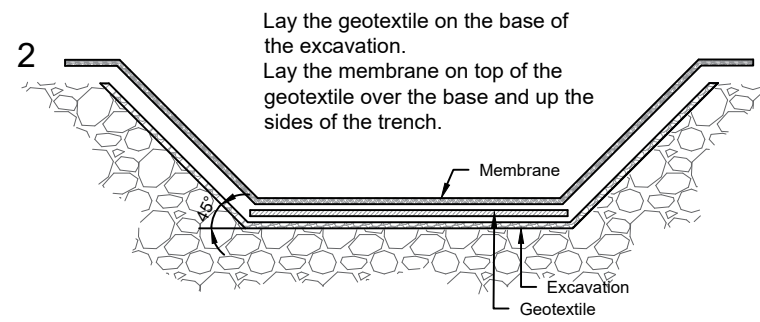
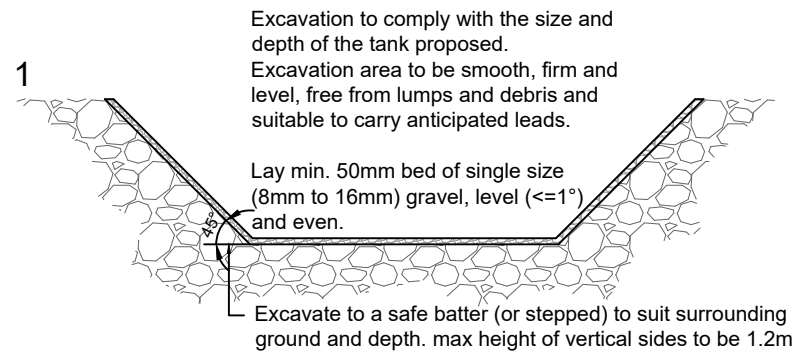

Geomembrane:  
1mm Thick LLDPE Geomembrane with a density of at least 0.939g/cm<sup>3</sup>

Geotextile:  
300g/m<sup>2</sup> Non-woven, needle punched geotextile

Geomembranes and Geotextiles with characteristics less than those specified are unlikely to be suitable and are therefore not recommended for use with Graf UK systems for this application

**3a** Assemble Baseplate and Ecobloc Maxx crate as shown below.

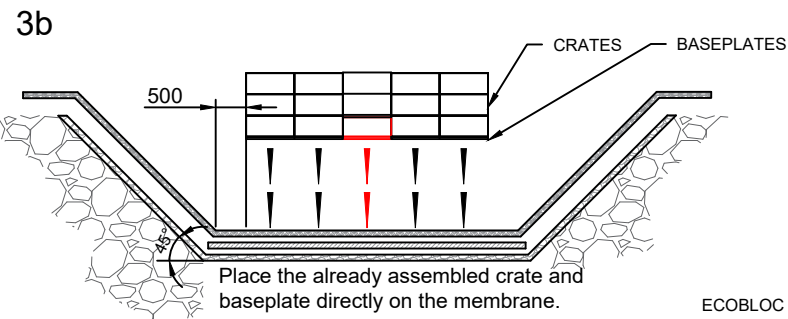
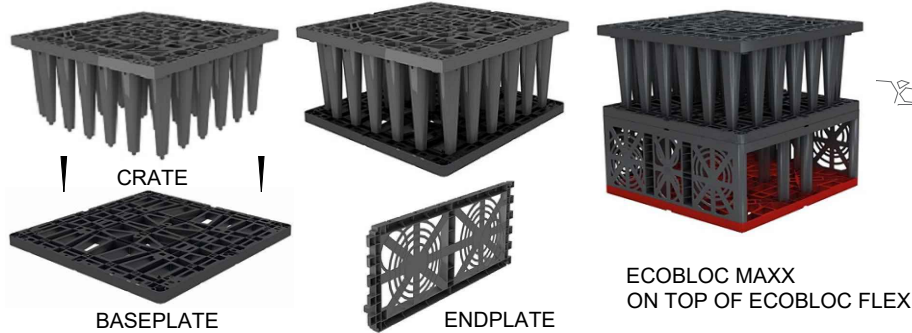

Mixed crates to be constructed as labeled below

MAXX	MAXX	MAXX	MAXX	MAXX
MAXX	MAXX	MAXX	MAXX	MAXX
MAXX	MAXX	FLEX	MAXX	MAXX

ECOBLOC MAXX BASEPLATE

ECOBLOC MAXX CRATE

ECOBLOC FLEX CRATE

ECOBLOC FLEX BASEPLATE

Remove a crate from the stack, rotate it 90° and place on top of the previously placed crate ensuring the connector clips are clipped locking the crates together.

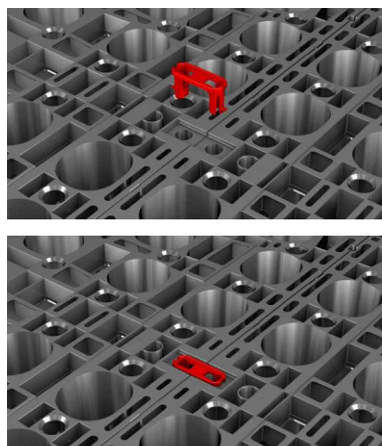

Connector clips are Red for illustration purposes only and are Grey in colour

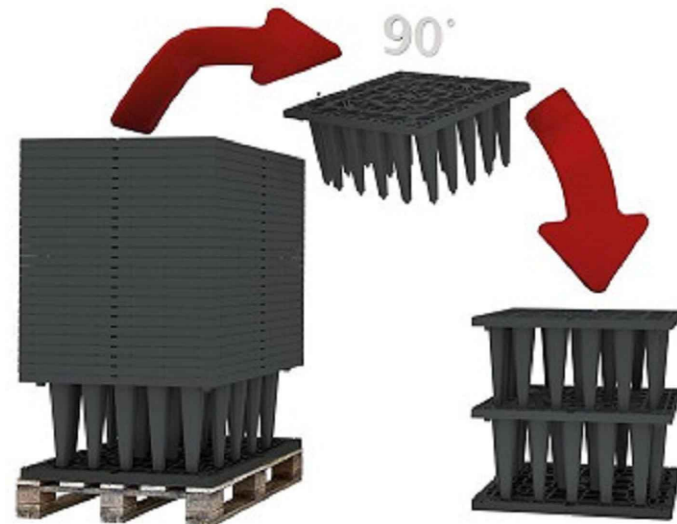

Attenuation Tank with Vario Shaft

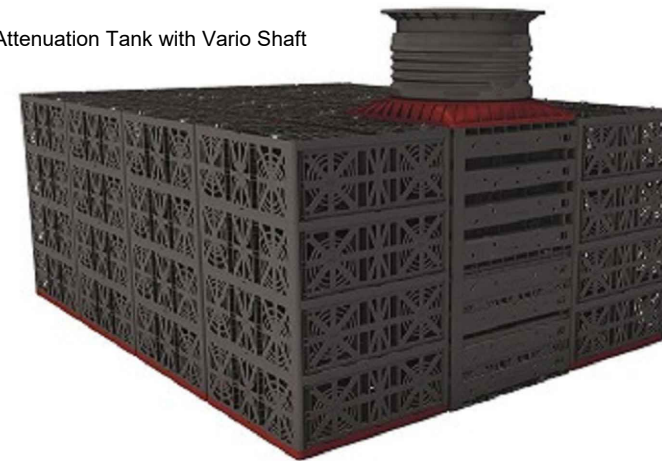

THIS DOCUMENT IS SUPPLIED IN STRICT CONFIDENCE AND MUST NOT BE LENT, REPRODUCED OR DISCLOSED TO ANY THIRD PARTY WITHOUT THE WRITTEN CONSENT OF GRAF UK LIMITED

**DO NOT SCALE - IF IN DOUBT ASK**

Notice: This drawing is issued only as a guideline and is an estimate of the materials required to construct the drainage system, it should not be used for construction purposes.

Graf UK Ltd makes no warranty or guarantee in relation to the suitability of any of the layout details shown on this drawing in relation to a particular scheme.

INSTALLATION METHOD:-

- Excavate the trench with a safe batter (or stepped) ensuring the footprint allows for sufficient space between tank and the sides. (minimum 500mm around all sides of the tank).
  - Mark out the position of the tank including inlets and outlets.
  - Lay min. 50mm of single sized non angular stone (8 to 16mm) as a base for the tank. This can be laid to a maximum fall of 1°.
- Lay the Geotextile over the base the excavation, overlapping any joins by a minimum of 300mm
  - Lay the Membrane on top of the Geotextile over the base and up the sides of the trench.
  - Membrane must be joined by thermal fusion heated wedge welding. It is recommended that the Dual Seam method is used as this generates an unwelded channel which can be pressured with air to check the integrity of the weld.
  - The membrane and geotextile used must meet the specification stated on the drawing.
- Assemble EcoBloc Maxx Crate and Baseplate, position leg ends into corresponding holes in the Baseplate. The crate will only fit in the correct orientation. Push down firmly to ensure Crate is located correctly. Assemble the row of EcoBloc Flex Crate with baseplates where inspection run is required. If a Vario shaft is to be included within the tank make sure the Vario Shaft base is in position located (Vario Shaft bases do not require a crate baseplates).
  - Install already assembled Crates and Baseplates onto the membrane until the first layer is complete. Insert retaining clips into each adjacent Crate.
  - Check and make sure the Row of EcoBloc Flex Crates are in the correct located position where inspection run is required.
  - To install the next layer of Crates remove from the stack and turn 90° and position directly above the Crate below. Push down firmly to ensure Crate is located correctly.

NOTE: You will need to place an additional row of Ecobloc Maxx Baseplates directly on top of the EcoBloc Flex crates **only**. No more base plates are required.

  - Continue until all Crates have been installed, ensuring clips are used to secure each Crate.
  - Fit Endplates to the sides of each Crate by positioning the bottom in place then pushing firmly on the top section to locate into place.
- Fix adaptor plates to the sides of the crates in the required position for the inlet and outlet pipes.
  - Cut a hole in the Membrane and pull over the adaptor plate sealing the membrane around the spigot of the adaptor plate.
  - Pull Membrane up around the sides and fully wrap the crates, securing the lid in place by heated wedge welding to the side panels.
  - Cover top and sides with the Geotextile covering the entire tank to protect the Membrane.
  - Install vent pipe connection into the top of the tank at a suitable location.
  - Backfill around the tank and for 100mm above with non-angular stone. Backfill to finished ground level with suitable material in layers.
  - Connect inlet/outlet pipes using appropriate bandseals.
  - In order to prevent silt from entering the tank it is recommended that silt traps or catchpit manholes are installed upstream of any inlet. These should be regularly maintained to avoid the buildup of any silt.

N.B. Installation method may vary depending on depth of the tank and is project specific. For more information or technical questions please contact our Technical Department at Graf UK.

P2	REVISED NOTES	AP	21.09.22
P1	LATEST REVISION	AP	05.03.21
REV.	DESCRIPTION	BY	DATE

Attenuation Tank without Vario Shaft

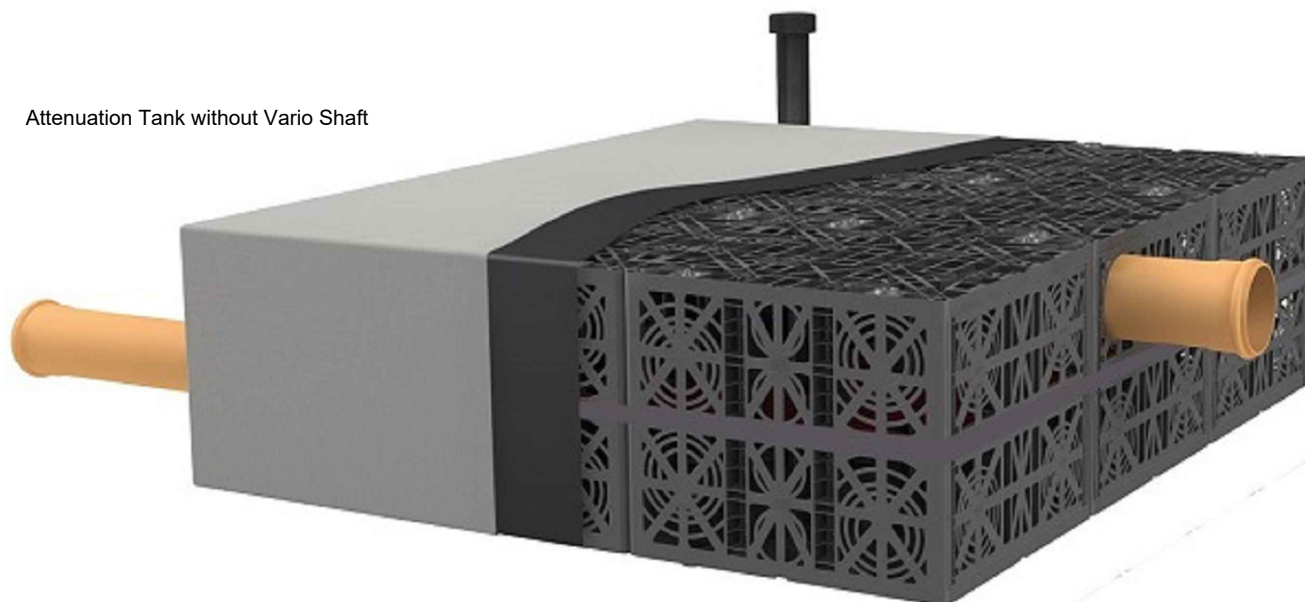

Endplates are then clipped to the tank where required.

Wrap the crates with the geomembrane ensuring it is heat welded/sealed then wrap the geotextile to protect the membrane.

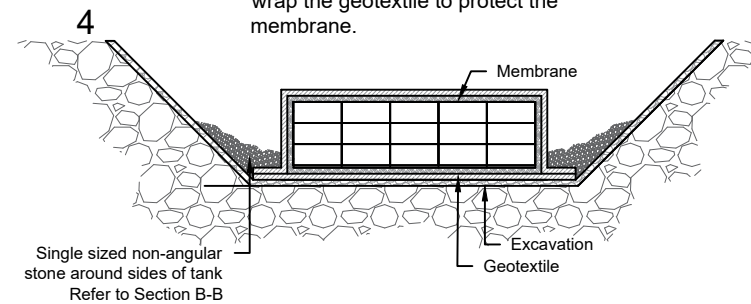

**GRAF** GRAF UK Limited

GRAF UK Limited, Regen House, Beaumont Road, Banbury, Oxfordshire, OX16 1RH

T: 01608 661500

F: 01295 211333

E: info@grafuk.co.uk

www.grafuk.co.uk

DRAWN :	AP	DATE :	05.03.2021
CHECKED :	MC	SCALE :	VARIOUS@A3

PROJECT  
**GRAF STANDARD DETAILS**

DESCRIPTION  
**ATTENUATION TANK using GRAF ECOBLOC MAXX AND FLEX**

DRAWING No.	REV.
STANDARD DETAIL_MAXX AND FLEX	P2 (Pg.2)