

RAIN BLOC ATTENUATION

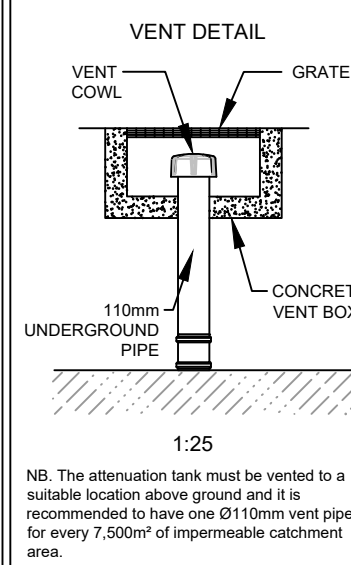
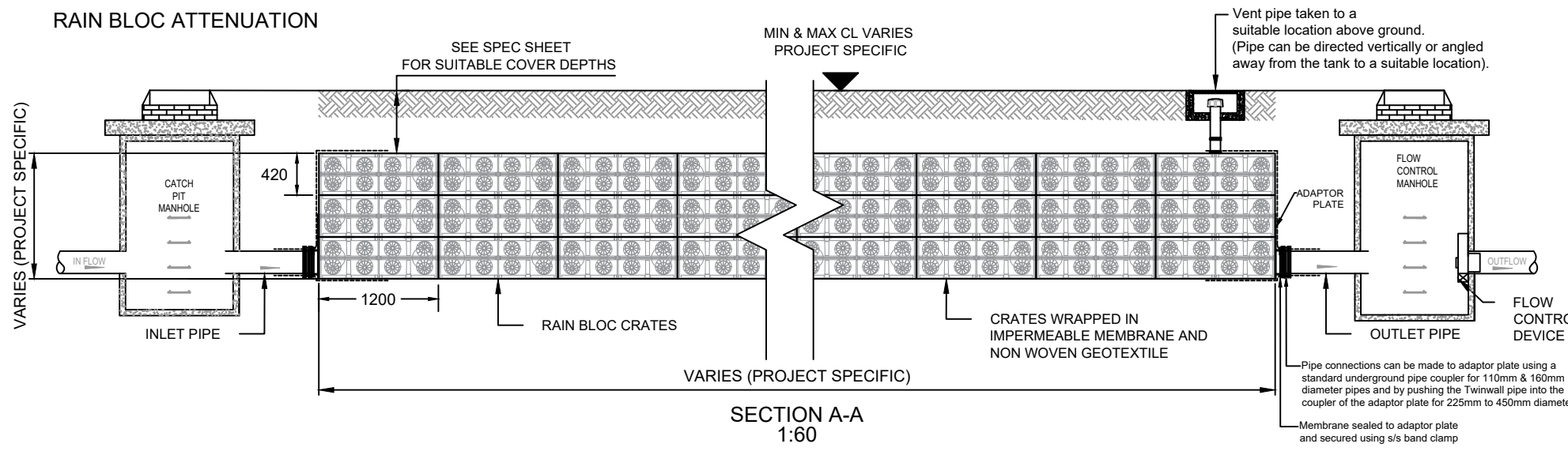

THIS DOCUMENT IS SUPPLIED IN STRICT CONFIDENCE AND MUST NOT BE LENT, REPRODUCED OR DISCLOSED TO ANY THIRD PARTY WITHOUT THE WRITTEN CONSENT OF GRAF UK LIMITED

DO NOT SCALE - IF IN DOUBT ASK

Notice: This drawing is issued only as a guideline and is an estimate of the materials required to construct the drainage system, it should not be used for construction purposes.
Graf UK Ltd makes no warranty or guarantee in relation to the suitability of any of the layout details shown on this drawing in relation to a particular scheme.

- NOTES:-
- All dimensions in mm, unless otherwise stated.
 - All dimensions are nominal and may vary within manufacturing tolerances.
 - All site temporary enabling works by others.
 - Graf products to be installed in strict accordance with Graf recommendations.
 - This drawing is intended for guidance only. Confirmation of the suitability for a particular project should be sought from the consulting engineers prior to final design or commencement of any construction works.

RAIN BLOC



Crate	
Dimensions (mm)	1200 x 600 x 420
Gross Volume (m3)	0.300m ³
Net Volume (m3)	0.285m ³
Material	Polypropylene (Upcyclen TV30)
Weight	17kg
Void Ratio	95%
Inspectable	No
*UCS Vertical	450 kN/m ²
*UCS Lateral	150 kN/m ²
*Ultimate Compression Strength	

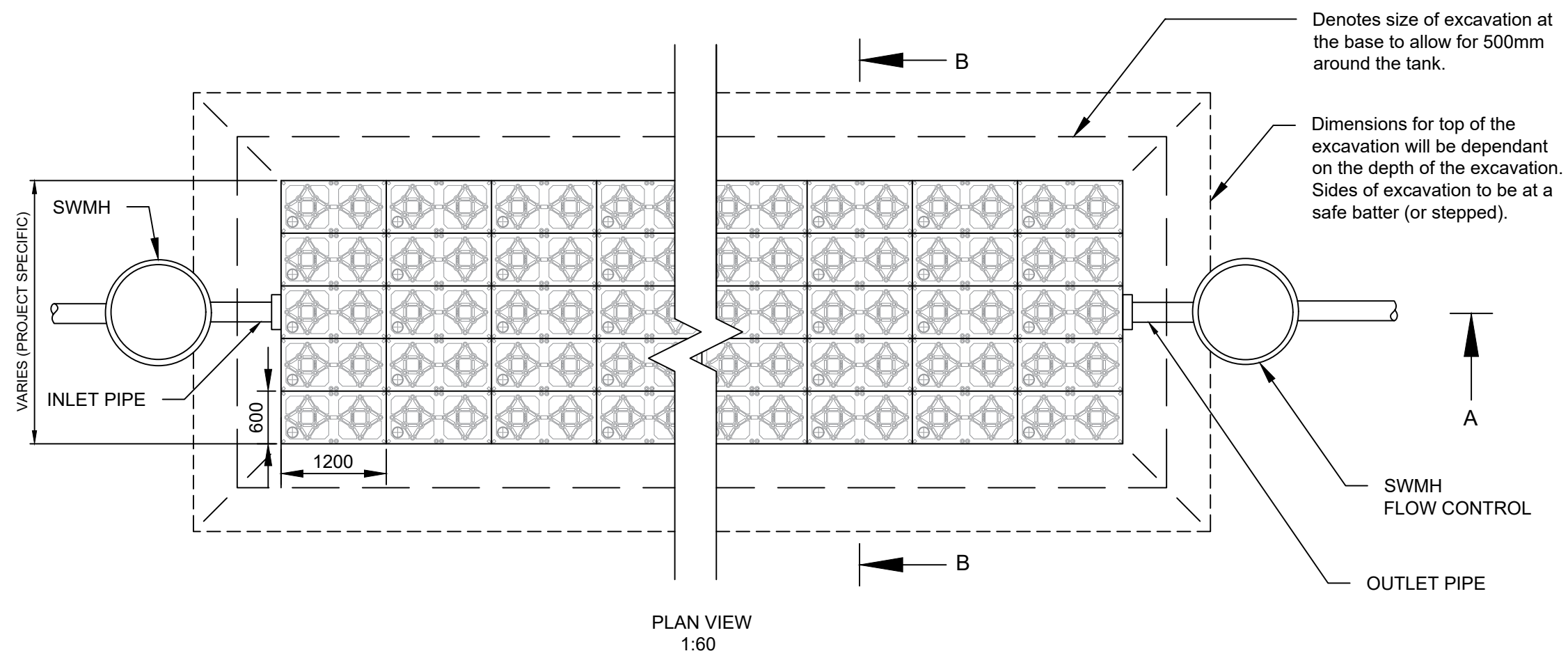

NOTE: EXCAVATION TO EXCEED TANK SIZE BY 500MM ON ALL SIDES TO ALLOW FOR ACCESS

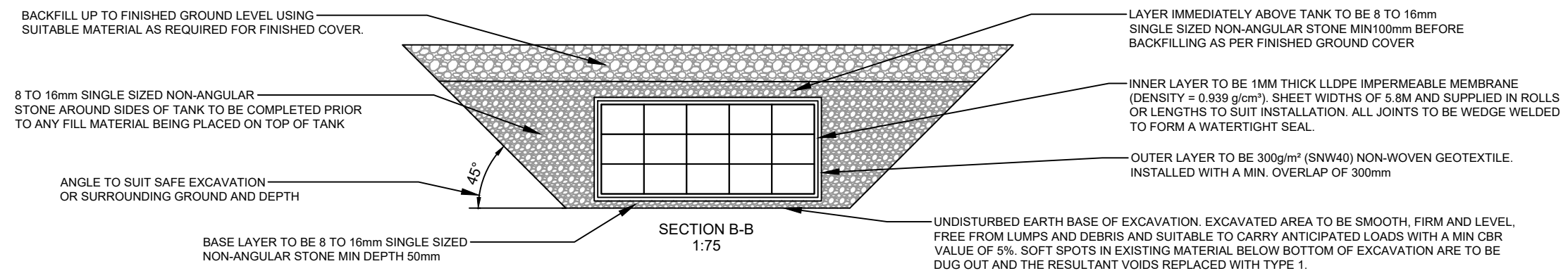

P3	UPDATED NOTES	AP	21.09.22
P2	DETAILS UPDATED FOR NEW RAINBLOC CRATE	MC	02.02.21
REV.	DESCRIPTION	BY	DATE

GRAF GRAF UK Limited

GRAF UK Limited, Regen House, Beaumont Road, Banbury, Oxfordshire, OX16 1RH

T: 01608 661500 F: 01295 211333

E: info@grafuk.co.uk www.grafuk.co.uk

DRAWN :	DB	DATE :	05.10.2018
CHECKED :	MC	SCALE :	AS STATED

PROJECT

GRAF STANDARD DETAILS

DESCRIPTION

ATTENUATION TANK using GRAF RAIN BLOC

DRAWING No.	REV.
STANDARD DETAIL.RAIN BLOC. P3	P3
	(Pg.1)

DO NOT SCALE - IF IN DOUBT ASK

Notice: This drawing is issued only as a guideline and is an estimate of the materials required to construct the drainage system, it should not be used for construction purposes.

Graf UK Ltd makes no warranty or guarantee in relation to the suitability of any of the layout details shown on this drawing in relation to a particular scheme.

INSTALLATION METHOD:-

1. a) Excavate the trench with a safe batter (or stepped) ensuring the footprint allows for sufficient space between tank and the sides. (minimum 500mm around all sides of the tank).
 b) Mark out the position of the tank including inlets and outlets.
 c) Lay min. 50mm of single sized non angular stone (8 to 16mm) as a base for the tank. This can be laid to a maximum fall of 1°.
2. a) Lay the Geotextile on the base of the excavation, overlapping any joins by a minimum of 300mm
 b) Lay the Geomembrane on top of the Geotextile over the base and up the sides of the trench.
 c) Membrane must be joined by thermal fusion heated wedge welding. It is recommended that the Dual Seam method is used as this generates an unwelded channel which can be pressured with air to check the integrity of the weld.
 d) The membrane and geotextile used must meet the specification stated on the drawing.
3. a) Place the first layer of crates until complete ensuring clips are used to secure each crate.
 b) Continue building the tank up until all crates have been installed to the dimensions specified, project specific.
4. a) Fix adaptor plates to the sides of the crates in the required position for the inlet and outlet pipes.
 b) Cut a hole in the geomembrane and pull up over the adaptor plate sealing the membrane around the spigot of the adaptor plate.
 c) Pull membrane up around the sides and fully wrap the crates, securing the lid in place by heated wedge welding to the side panels.
 d) Wrap and overlap the geotextile covering the entire tank to protect the geomembrane.
 e) Install vent pipe connection into the top of the tank at a suitable location.
 f) Backfill around the tank and for 100mm above with non-angular stone. Backfill to finished ground level with suitable material in layers.
 g) Connect inlet/outlet pipes using appropriate bandseals.
 h) In order to prevent silt from entering the tank it is recommended that silt traps or catchpit manholes are installed upstream of any inlet. These should be regularly maintained to avoid the buildup of any silt.

N.B. Installation method may vary depending on depth of the tank and is project specific. For more information or technical questions please contact our Technical Department at Graf UK.

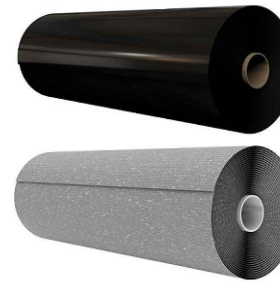
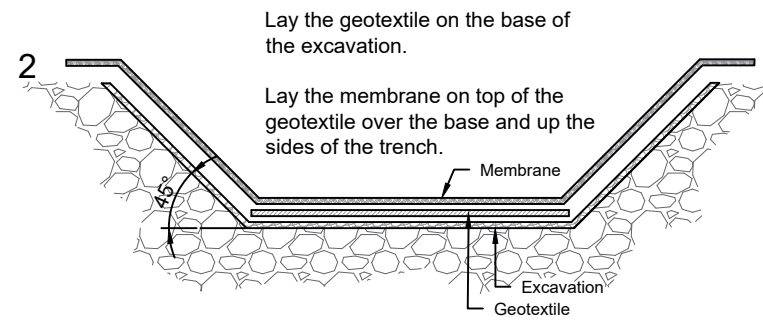
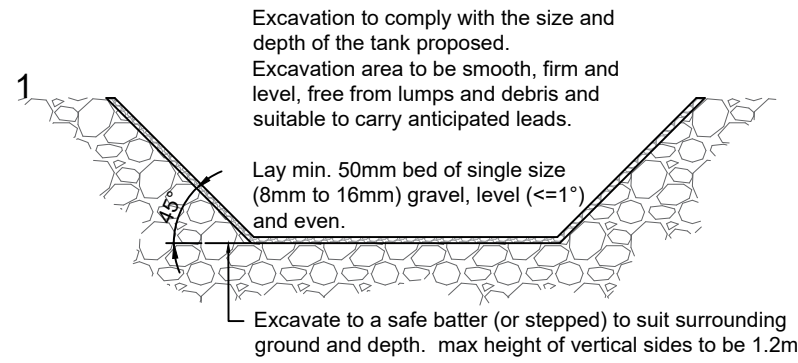

Geomembrane:
1mm Thick LLDPE Geomembrane
with a density of at least 0.939g/cm³

Geotextile:
300g/m² Non-woven,
needle punched geotextile

Geomembranes and Geotextiles with characteristics less than those specified are unlikely to be suitable and are therefore not recommended for use with Graf UK systems for this application

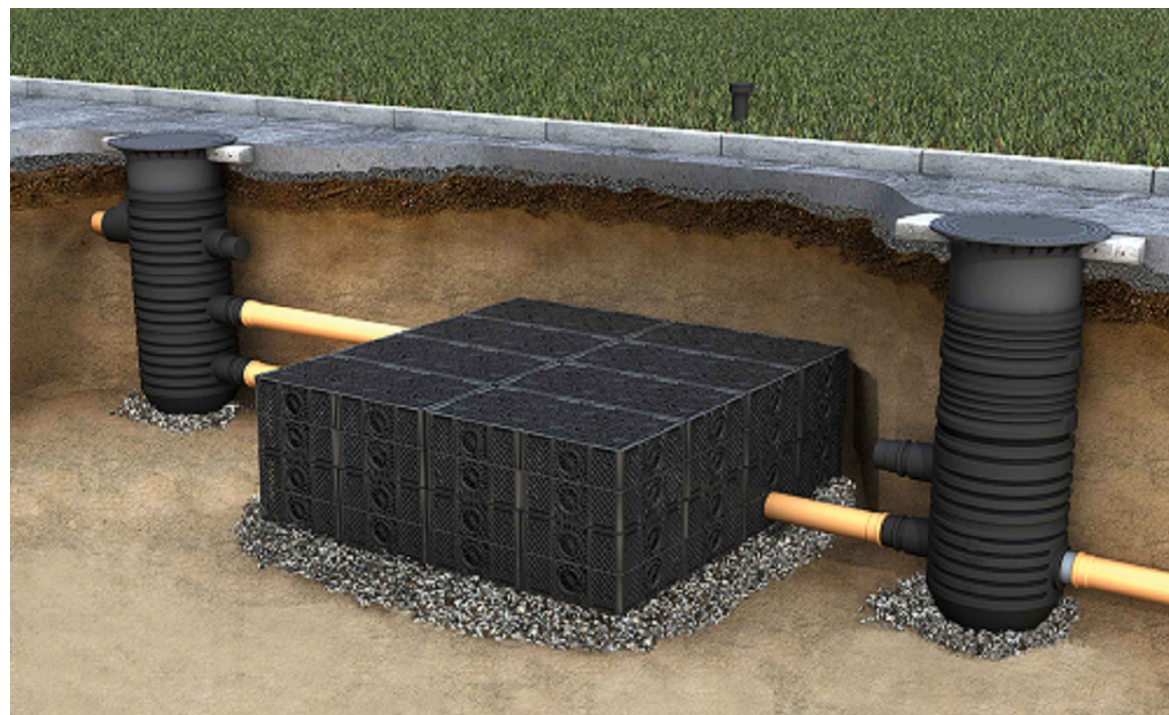
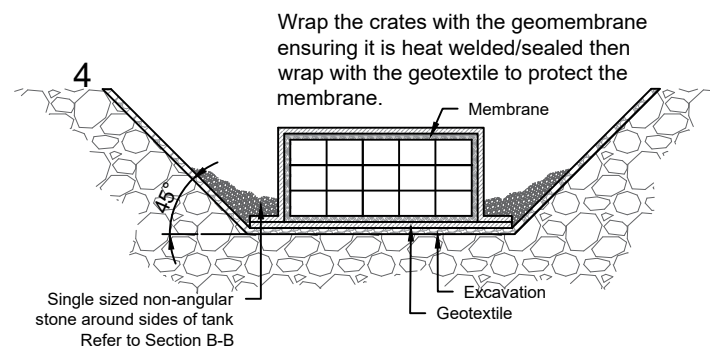
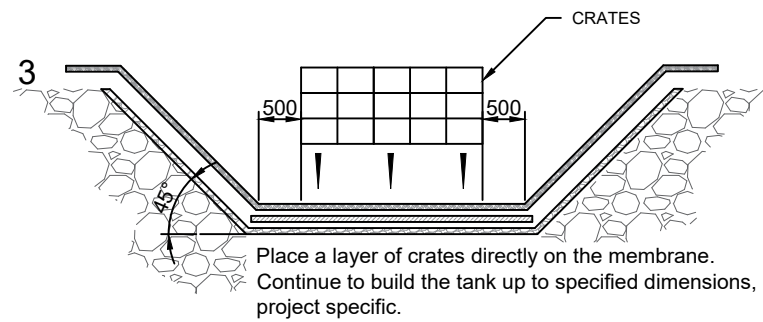

(Drawing for illustrative purposes only)

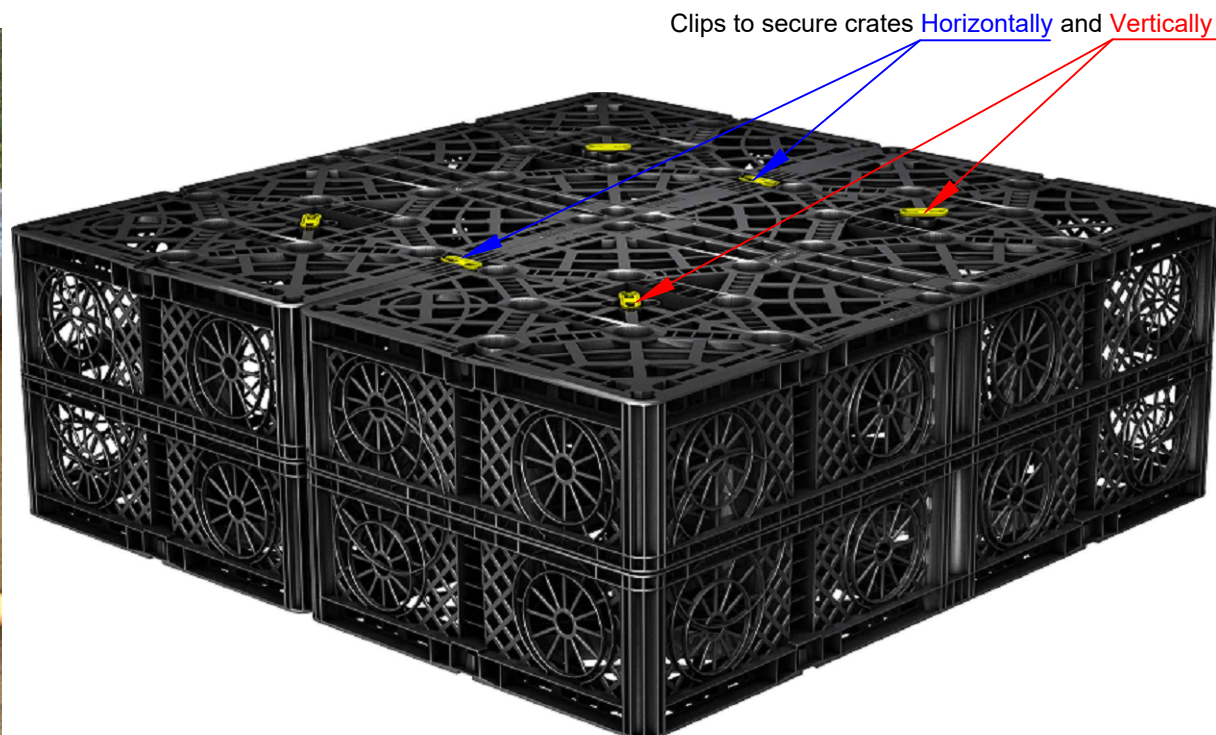

P3	UPDATED NOTES	AP	21.09.22
P2	DETAILS UPDATED FOR NEW RAINBLOC CRATE	MC	02.02.21
REV.	DESCRIPTION	BY	DATE

GRAF GRAF UK Limited

GRAF UK Limited, Regen House, Beaumont Road, Banbury, Oxfordshire. OX16 1RH
 T: 01608 661500 F: 01295 211333
 E: info@grafuk.co.uk www.grafuk.co.uk

DRAWN :	DB	DATE :	05.10.2018
CHECKED :	MC	SCALE :	VARIOUS@A3

PROJECT
GRAF STANDARD DETAILS

DESCRIPTION
**ATTENUATION TANK
using GRAF RAIN BLOC**

DRAWING No.	REV.
STANDARD DETAIL.RAIN BLOC.	P3
	(Pg.2)